

SECTION A-A
SCALE 1 : 1

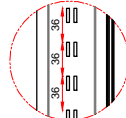

DETAIL E
SCALE 3 : 1

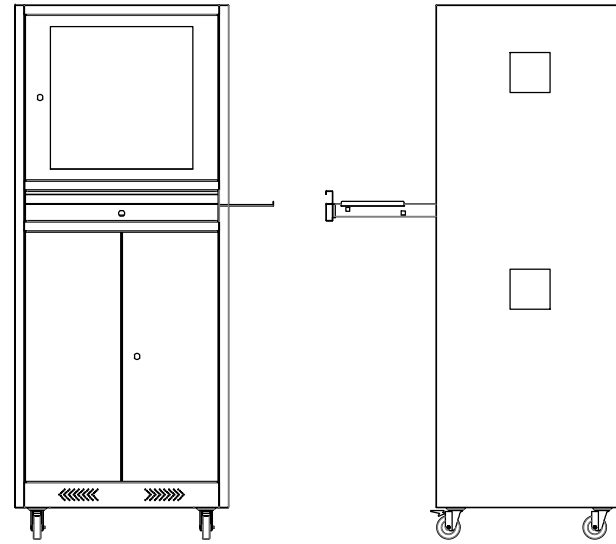
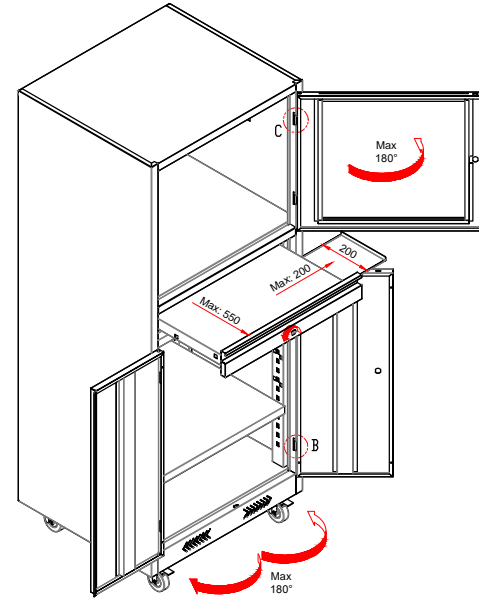

DETAIL C
SCALE 3 : 1



DETAIL B
SCALE 3 : 1

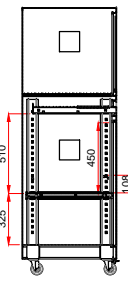
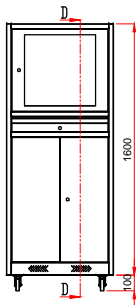

SECTION D-D
SCALE 1 : 2

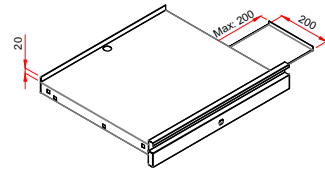
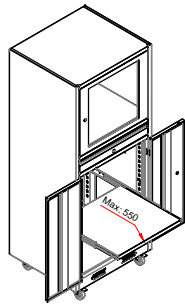

OPTIONAL

CODE
IPC/M1.1706860.

GÜRKAN

1600*680*600 mm ENDÜSTRİYEL BİLGİSAYAR DOLABI + TEKER